

dTRANS Lf 01 µP Transmitter / Controller for electrolytic conductivity

Type 202540

Brief description

This instrument measures and controls the conductivity of aqueous solutions. The transmitter has two analog and two logic inputs. The first analog input is suitable for the connection of conductivity electrodes with cell constants of 0.01, 0.1, 1.0, 3.0 or 10.0 [1/cm]. The second analog input can be used to connect Pt100 or Pt1000 resistance thermometers. The instrument features two 4-digit 7-segment displays for indicating the conductivity process value (red) and the temperature (green). During programming, the displays provide comments on the inputs. A great variety of control tasks can be handled by the various output options (relay contacts and / or analog outputs). The two relay "make" contacts that are provided on the instrument as standard can be configured as a limit controller and / or pulse width or pulse frequency controllers, or as a modulating controller. To obtain analog (continuous) controller outputs, the optional analog outputs must be configured accordingly. All controller outputs can be configured for a P, PI, PD or PID control action. In the entry level version, the instrument provides two relay "make" contacts and one logic output (0/5V). Two additional outputs can, according to choice, be fitted as relay changeover contacts and / or analog outputs (process value output or analog controller output) or as a serial interface (Profibus-DP or Modbus / Jbus protocol).



Type 202540 / ...



Type 202540 / .../640

Block structure

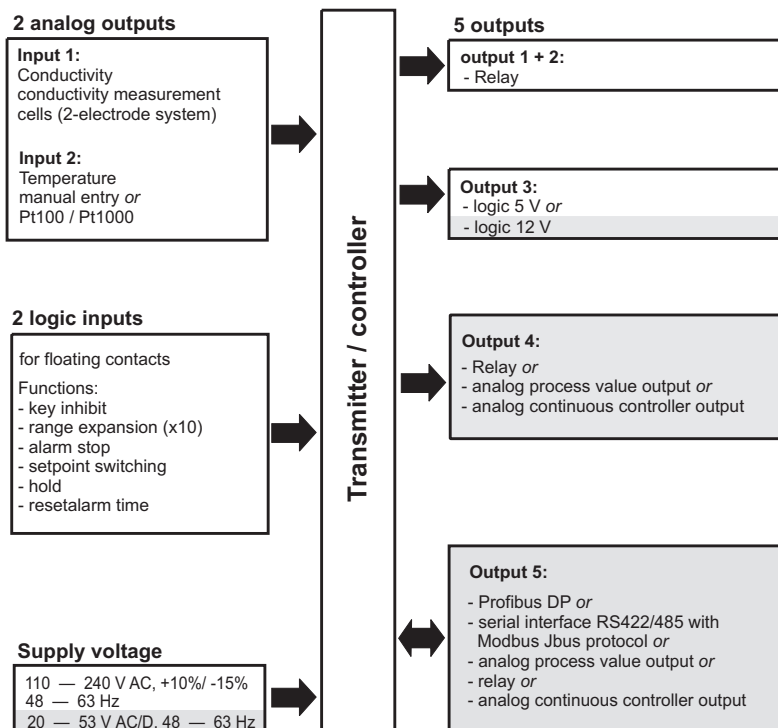

extra codes / options

Key features

- Panel-mounting instrument, just 96 x 48 x 110 mm
- Conductivity display (in µS/cm or mS/cm) and temperature
- 2 relays as standard, freely programmable as limit controller or P, PI, PID, PD controller with pulse width/pulse frequency output or modulating controller
- 2 electrically isolated analog outputs 0(4) — 20 mA / 0(2) — 10 V freely selectable and scalable for conductivity or temperature (option)
- 2 logic inputs
- Monitoring the temperature of the medium is possible
- Calibration procedure for the relative cell constant and temperature coefficient of solution being measured
- OPTION: Profibus-DP or serial interface RS485/422 with Modbus/Jbus protocol
- Measurement ranges from 0 — 0.5 µS to 0 — 200 mS in **one instrument**

Zulassungen



Operation

For easy programming and operation, the controller parameter and configuration data are assigned to various levels.

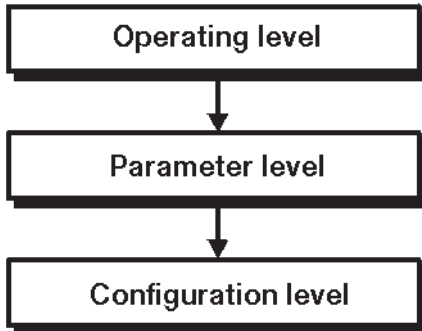

Code words protect the levels from unauthorized access.

Membrane keys ensure simple and user-friendly operation.

The two LED displays show the parameter symbols and the corresponding values.

Operating level

The lower display, for example, shows the symbol, the upper display shows the corresponding value. Setpoints SP1 and SP2 can be altered by using the membrane keys.

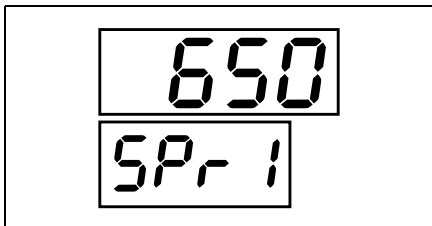

Parameter level

The controller is adapted to the control loop at this level. The appropriate parameters appear here, with symbol and value.

Only those parameters will be indicated which correspond to the configuration of the controller (configuration level).

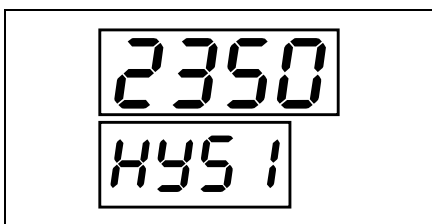

Configuration level

This level is used to adapt the controller to the control task, or for adaptation of the inputs and outputs.

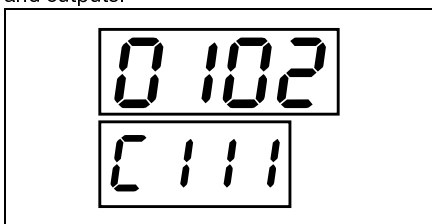

Indications / controls

(1) LED display in mS/cm	(6) PGM key for selection of parameters and confirmation of entries
(2) Status indicators (yellow) for outputs 1 to 4	(7) 4-digit temperature display (LED, green, 8 mm high)
(3) Increment key for altering parameters or manual operation of relay K2	(8) 4-digit process value indication (LED, red, 13 mm high)
(4) Decrement key for altering parameters or manual operation of relay K1	(4) "CAL": Initiates calibration + (relative cell constant K_{rel} or temperature coefficient α)
(5) EXIT key to leave the levels	(3) + Initiate manual operation or hold (5)

Calibration options

□ Calibration of the cell constant

Subject to manufacturing tolerances, the cell constant of the conductivity measuring cell may deviate slightly from its nominal (printed) value. In addition, the cell constant may change during operation (due to deposits or wear). This results in a change of the output signal from the cell. The dTRANS Lf 01 offers the user the possibility of compensating any deviation from the nominal value of the cell constant through **manual entry** (range 80 – 120%) or **automatic calibration** of the relative cell constant K_{rel} .

□ Calibration of the temperature coefficient α

The conductivity of almost all solutions is temperature-dependent. To ensure correct measurement, it is therefore necessary to know both the temperature and temperature coefficient α [% per °C] of the measuring solution. The temperature can either be measured automatically, with a Pt100 or Pt1000 temperature probe, or set manually by the user.

When using a dTRANS Lf 01, the temperature coefficient can be determined automatically or entered manually, within the range 0 – 5.5 % per °C.

Additional functions of the dTRANS Lf 01

□ Programmable response of the process value output to underrange / overrange

On underrange or overrange, the process value output can move to the following

operational states:

-4%, 0%, 100% or 110% freely selectable

Example: The instrument is programmed to

4 – 20 mA corresponding to
0 – 30 mS/cm

The instrument can be set up so that, on exceeding 30 mS/cm, the output signal is either held at 20 mA (100%) or will jump to 22 mA (110%). The 22 mA value can then be recognized as "irregular" by a connected PLC.

□ Bilinear output

This function divides the signal for the analog process value output into two linear portions (0 – 50% and 50 – 100% of the output signal), with a knee-point at 50% of the output signal. The knee-point of the characteristic can be shifted along the dotted 50% line. The 50% factory setting produces a straight-line characteristic.

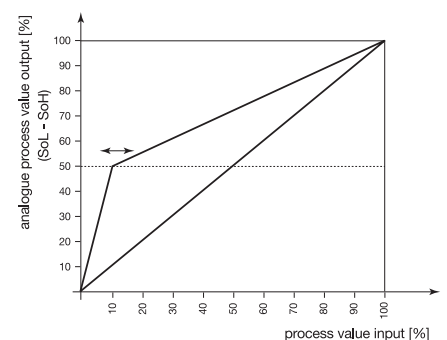

The bilinear characteristic is used when the "normal" measurement range is likely to be frequently exceeded.

Example: The normal measurement range spans 0 – 20 µS/cm.

However, measurements of up to 80 µS/cm can also occur.

In this case, the range 0 – 100 µS/cm will be selected, and the knee-point set at 20% of this range (20% of 100 µS/cm corresponds to 20 µS/cm).

This results in measurements in the range 0 – 20 µS/cm being converted into an output signal 0 – 10 mA.

Measurements in the range 20 – 100 µS/cm will be converted into an output signal 10 – 20 mA.

□ The response of the controller relays to "Hold" can be defined

"Hold" is initiated either manually, using the keys, by a logic input, or by an alarm event. The outputs of the relays K1 and K2 can move to the following (programmable) states on "Hold":

0%	Relay de-energized
50% output	For dynamic controllers, 50% of the maximum pulse width or frequency is produced
100% output	Relay is energized, or maximum pulse width / frequency
Output accepted	The present output continues to be produced

□ In "Manual" mode, the relays K1 and K2 are operated manually, by using the keys. Either key or switch operation can be selected, by a setting at the parameter level.

Key operation: The relay is switched as long as the key is pressed (e.g. for manual dosing).

Switch operation: The first key stroke switches the relay on – the second switches it off again (toggle action), e.g. for emptying large tanks.

□ Simulation of the process value output

In the manual mode, the process value output (0/2 – 10 V or 0/4 – 20 mA, depending on the setting) can be switched in 10% steps from 0 – 100%.

Application: "Dry-run" commissioning of the plant (without measuring cell, fault search, servicing).

□ Controller output functions

Output 1 (relay): Switching, with pulse frequency or pulse width action / limit monitoring / switched off. Switching function can be reversed.
MAX / MIN limit comparator.

Output 2 (relay): Switching, with pulse frequency or pulse width action / limit monitoring / MAX / MIN limit comparator for temperature / switched off. Switching function can be reversed.
MAX / MIN limit comparator.

Output 3, relay or analog process value output: "Hold" / alarm pulse contact; alarm steady contact / MAX / MIN comparator for temperature input / output of conductivity process value (only for analog process value output) / output of temperature process value (only for analog process value output) / analog controller output (only for analog process value output) / no function.

Output 4, logic output: "Hold" / alarm pulse contact / alarm steady contact / MAX limit comparator for temperature input / MIN limit comparator for temperature input / no function.

Output 5, relay or analog process value output: "Hold" / alarm pulse contact; alarm steady contact / MAX / MIN limit comparator / output of conductivity process value (only for analog process value output) / output of temperature process value (only for analog process value output) / analog controller output (only for analog process value output) / no function.

Limit comparator (limit monitor)

Controller outputs 1 to 5 (depending on the instrument version) can be assigned to a limit-monitoring function.

For each one, the direction of switching (pulled in on going above, or going below a limit), pull-in and/or drop-out delay, and a hysteresis can all be defined.

Interface

The microprocessor/controller can be optionally fitted with an RS422/RS485 interface. This is used for communication with higher-level systems and integration into a data network. The transmission protocol can be either Profibus-DP or Modbus/Jbus.

Technical data

Inputs

Analog input 1

Electrolytic conductivity cell, with cell constants: 0.01, 0.1, 1.0, 3.0, 10.0 [1/cm] (2-electrode principle).

The cell constants can be adjusted over a range 80 – 120%.

Lead compensation, input 1

The influence of long cables in the measuring ranges above 20 mS/cm can be compensated by entering the lead resistance, in the range 0.00 to 9.99 Ω.

Analog input 2

Resistance thermometer Pt100 or Pt 1000, in 2- or 3-wire circuit
-50 to +250°C
Measurement display in °C or °F

Lead compensation, analog input 2

The lead resistance can be compensated in software by a correction of the process value.

This is not required if the resistance thermometer is connected in a 3-wire circuit. When a resistance thermometer is connected in a 2-wire circuit, lead compensation can be provided by using an external compensation resistor.

Functional description of logic inputs 1 and 2

The two standard logic inputs can be operated by floating contacts (relays) from a PLC, or by switches. The following functions can be selected and assigned:

Key inhibit: The PLC or a key switch can be used to lock the keys on the transmitter, to prevent unauthorized entries being made.

Setpoint changeover: For comfortable process control. As long as the logic input is not operated, setpoint pair SP1 and SP2 is active. If the appropriately configured logic input is operated, then the second setpoint pair is activated (setpoint switching).

Freeze measurement: The indicated measurement and the process value output no longer change.

"Hold": This function can be used (for instance, by a supervisory PLC) to put the instrument into the secure "Hold" state. The response of the controller to "Hold" is as previously defined.

"Hold reversed": The same function as for HOLD, but when the logic input is open.

Alarm stop: The alarm generation via the configured output is reset or prevented, but the alarm LED (e.g. K4) continues to blink as a warning.

Reset alarm time: The alarm generation via the configured output is prevented. The alarm delay time is set to zero, but is restarted when the logic input becomes inactive and the start conditions are fulfilled once more. The alarm LED (e.g. K4) continues to blink as a warning.

Range expansion (x10): If only a small portion of the measurement range is used, it may be advantageous for the transmitter to react to 0 – 10% of the process value by producing 0 – 100% of the output signal.

Measurement and control range

0 – 0.5 µS to 0 – 200 mS, depending on the cell constant, see table on page 5.

Deviation from characteristic
≤ 1.0% of measurement range

Ambient temperature error
≤ 0.25% per 10 °C

Reference temperature
25°C

Temperature display
-50 to +250°C (can be switched to °F)

Deviation from characteristic
≤ 0.25% of measurement range

Ambient temperature error
≤ 0.1% per 10 °C

Outputs

2 relay outputs, 1 logic output, 1 analog process value output or 1 additional relay, and 1 serial interface are available.

1. Relay, output 1 / 2 (standard)

Make contact (n.o., can also be configured as n.c. break contact)
 contact rating: 3A, 250V AC
 with resistive load
 contact life:
 > 5×10^5 operations at rated load

2. Logic output, output 4

0/5V $R_{load} \geq 250 \Omega$ (standard)
 or
 0/12V $R_{load} \geq 650 \Omega$ (option)

3. Process value output, output 3 or 5 (option)

freely configurable:
 0(2) — 10V $R_{load} \geq 500 \Omega$
 0(4) — 20mA $R_{load} \geq 500 \Omega$
 electrically isolated from the inputs:
 $\Delta U \leq 30V$ AC or
 $\Delta U \leq 50V$ DC.

Deviation from characteristic of the output signal

$\leq 0.25\% \pm 50$ ppm per °C

4. Relay, output 3 or 5 (option)

(only for instruments without a process value output)
 changeover contact
 contact rating: 3A, 250V AC
 with resistive load
 contact life:
 > 5×10^5 operations at rated load

5. Interface RS422 / RS485, Output 5 (option)

electrically isolated

Baud rate

4800 / 9600bps

Protocol

Modbus / Jbus or
 Profibus-DP

General controller data**A/D converter**

resolution > 15 bit

Controller type

Outputs 1 and 2

limit controller and / or pulse width or pulse frequency controller, modulating controller.

Freely configurable and mixable

K3 / K5:

continuous controller

Control action

configurable as P, PI, PID or PD.

Sampling time

210 msec

Measuring circuit monitoring

Input 1:

out-of-range, sensor monitoring

Input 2:

out-of-range, probe short-circuit,
 probe break

The outputs move to a defined (configurable) status.

Data backup

EEPROM

Supply voltage

110 — 240 V AC $\pm 10\% / -15\%$,

48 — 63 Hz or

20 — 53 V AC/DC, 48 — 63/0 Hz,

Power consumption

approx. 8V A

Electrical connection**Instrument for switchgear cabinet (basic version)**

via gold-plated faston connectors to
 DIN 46 244/A; 4.8mm x 0.8mm

Wall-mounting housing**(extra code /640)**

via screw terminals
 (wire cross-section up to 2.5 mm²)
 6 cable glands (1 x M16, 5 x M20)

Permissible**ambient temperature**

0 to +60°C

Permissible**ambient temperature limits**

-10 to +55°C

Permissible storage temperature

-40 to +70°C

Climatic conditions

rel. humidity $\leq 75\%$, no condensation

Enclosure protection

to EN 60 529

Instrument for switchgear cabinet

front IP65 / rear IP20

Wall-mounting instrument

IP67

Electrical safety

to EN 61 010

clearance and creepage distances for

- overvoltage category II

- pollution degree 2

Electromagnetic compatibility

to EN 61 326

interference emission: Class B

interference immunity: to industrial requirements

Housing**Instrument for switchgear cabinet (basic version)**

panel-mounting housing in conductive plastic

to DIN 43 700, base material ABS

with plug-in controller module.

Wall-mounting housing**(extra code /640)**

base material PC

Operating position

unrestricted

Weight**Instrument for switchgear cabinet****(basic version)**

approx. 320g

Wall-mounting housing (extra code /640)

approx. 1400 g

Option**Wall-mounting housing**

extra code /640

On request, the JUMO dTRANS Lf 01 can be

supplied built into a surface-mounting housing.

The housing is suitable for wall-mounting

or for mounting on a 35 x 7.5 mm DIN rail

to EN 50 022.

The housing is sturdy and provides IP67 protection

for the built-in instrument and is fitted with six cable glands. Unused cable glands can be tightly sealed using the blind grommets that are included in the delivery.

The electrical connection is made via screw terminals (wire cross-section up to 2.5 mm²).

Standard accessories

- 2 mounting brackets (not with extra code /640 (wall-mounting housing))
- 1 seal for panel-mounting (not with extra code /640 (wall-mounting housing))
- sundry items for wall-mounting (only with extra code /640 (wall-mounting housing))
- sundry items for DIN rail mounting (only with extra code /640 (wall-mounting housing))
- 1 Operating Manual B 20.2540.0.1

Optional accessory

Interface Description B 20.2530.2

Cell constants and measurement ranges

Cell constant K ^{B)}	Meas. range ^{B)}	Display with configured measurement (C111)		Range (rAng)
		µS	mS	
0.01	0 — 0.500 µS/cm	0.500	— ^{A)}	1
0.01	0 — 2.000 µS/cm	2.000	— ^{A)}	2
0.01	0 — 10.00 µS/cm	10.00	— ^{A)}	3
0.1	0 — 5.000 µS/cm	5.000	— ^{A)}	4
0.1	0 — 20.00 µS/cm	20.00	— ^{A)}	5
0.1	0 — 100.0 µS/cm	100.0	— ^{A)}	6
0.1	0 — 1.000 mS/cm	1000	1.000	7
0.1	0 — 5.000 mS/cm	5000	5.000	8
1.0	0 — 50.00 µS/cm	50.00	— ^{A)}	9
1.0	0 — 100.0 µS/cm	100.0	— ^{A)}	10
1.0	0 — 1.000 mS/cm	1000	1.000	11
1.0	0 — 5.000 mS/cm	5000	5.000	12
1.0	0 — 20.00 mS/cm	— ^{A)}	20.00	13
1.0	0 — 100.0 mS/cm	— ^{A)}	100.0	14
3.0	0 — 1.000 mS/cm	1000	1.000	15
3.0	0 — 5.000 mS/cm	5000	5.000	16
3.0	0 — 30.00 mS/cm	— ^{A)}	30.00	17
10.0	0 — 30.00 mS/cm	— ^{A)}	30.00	18
10.0	0 — 200.0 mS/cm	— ^{A)}	200.0	19

A) These settings are not permissible – they would cause an incorrect display

B) The selection of the measurement range and cell constant is made through the code number "Range"

Parameters

Parameter	Display	Value range	Comment
Alarm tolerance	AL1	0.000 — 9999*	The alarm is only generated when the level (setpoint + alarm tolerance) has been passed, and the alarm delay time has elapsed
Alarm delay	AL2	0 — 6000 sec	Delay time before the alarm contact is activated
Proportional band 1	Pb1	1 — 9999*	Influences the P action of the controller
Proportional band 2	Pb2		
Derivative time 1	dt1	0 — 9999 sec	Influences the D action of the controller If dt = 0, the controller has no D action.
Derivative time 2	dt2		
Reset time 1	rt1		
Reset time 2	rt2		
Minimum ON time 1 (for limit controller or pulse width controller) or minimum pulse width 1 (for pulse frequency controller)	tr1	0.2 — 999.9 sec	Determined by the technical data of the dosing device (solenoid valve, dosing pump)
Minimum ON time 2 (for limit controller or pulse width controller) or minimum pulse width 2 (for pulse frequency controller)	tr2		
Switching differential 1	HYS1	1 — 9999*	Defines the switch-off point for the control contacts
Switching differential 2	HYS2		
Switching differential 3	HYS3		
Switching differential 4	HYS4		
Switching differential 5	HYS5		

Parameter	Display	Value range	Comment
Pull-in delay 1	Ond1	0.0 – 999.9 sec	Delay time before the contact is activated
Pull-in delay 2	Ond2		
Pull-in delay 3	Ond3		
Pull-in delay 4	Ond4		
Pull-in delay 5	Ond5		
Drop-out delay 1	Ofd1	0.2 – 999.9 sec	Delay time until the contact moves back to the initial position
Drop-out delay 2	Ofd2		
Drop-out delay 3	Ofd3		
Drop-out delay 4	Ofd4		
Drop-out delay 5	Ofd5		
Pulse frequency 1	Fr1	0 – 150 pulses/min	Maximum frequency of pulses (operating a dosing pump, for instance)
Pulse frequency 2	Fr2		
Pulse period 1	Cy1	2.0 – 999.9 sec	The period in which a pulse is modulated
Pulse period 2	Cy2		
Output level limit, output 1	Y1	0 – 100%	The maximum output level for a pulse width / pulse frequency controller
Output level limit, output 2	Y2		
Actuator time	tt	15 – 3000 sec	For modulating controller

* Decimal point and dimensional unit corresponding to chosen range

Connection diagram

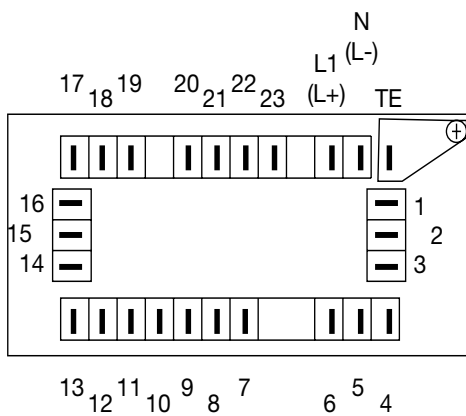

Rear view with faston connectors

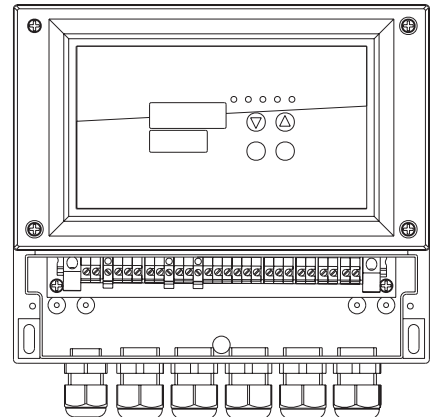

Wall-mounting housing (extra code /640) with terminal strip

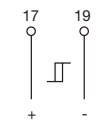
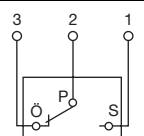
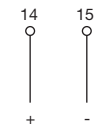

Outputs	K	Connections	Symbol
Relay 1 (K1) Status indication LED K1	1	23 common 22 make	
Relay 2 (K2) Status indication LED K2	2	21 common 20 make	
Relay 3 (K3) Status indication LED K3	3	16 break 15 common 14 make	
or analog process value output (electrically isolated)		15 - 14 +	

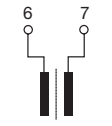
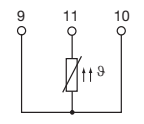
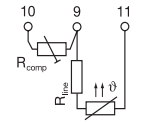
Logic output 1 (K4) Status indication LED K4	4	19 - 17 +	
Relay 4 (K5) No status indication or analog process value output (electrically isolated)	5	3 break 2 common 1 make	
		2 - 1 +	

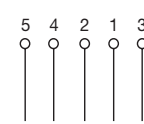
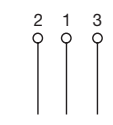
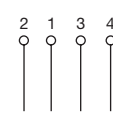
Meas. inputs	Connections		Symbol
Conductivity cell	6 7	6 Outer electrode, on coaxial cells 7 Inner electrode, on coaxial cells	
Resistance thermometer in 3-wire circuit	9 10 11		
Resistance thermometer in 2-wire circuit	9 10 11		

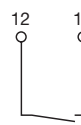
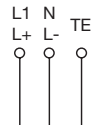
Meas. inputs	Connections		Symbol	
Serial interface RS422 (option)	RxD	5 RxD + 4 RxD -	Receive data 	
	TxD	2 TxD + 1 TxD -		Transmit data
	GND	3 GND		
Serial interface RS485 (option)	+	2 TxD/RxD +	Receive data / transmit data 	
	-	1 TxD/RxD -		
Serial interface Profibus-DP (option)	VP	4 supply voltage positive, (P5V)		
	RxD/TxD-P	2 receive/transmit data positive, B conductor		
	RxD/TxD-N	1 receive/transmit data negative, A conductor		
	GND	3 GND		
Logic input 1		13 19		
Logic input 2		12 19		
Supply voltage see nameplate	AC/ DC	AC: L1 phase/line N neutral TE technical earth	DC: L + L - 	

Connection for conductivity cell

	Conductivity cell (types)		dTRANS Lf 01
	Cap	Fixed cable	
Outer electrode		white	6
Inner electrode		brown	7
Temperature compensation	1	yellow	11
	3	green	10
Link			10
			+ 9

Dimensions

Type 202540 / ...

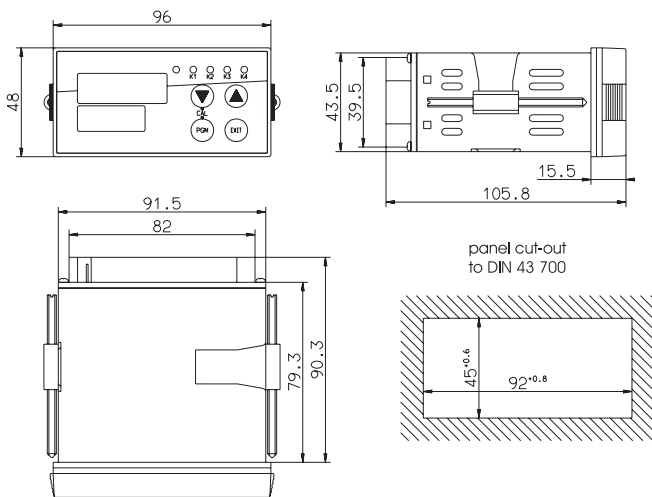

Panel cut-out to DIN 43 700
close mounting (minimum dimensions)

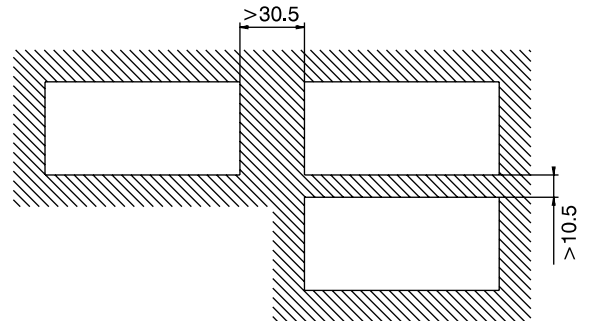

Option

Surface-mounting housing, extra code /640, IP67 protection

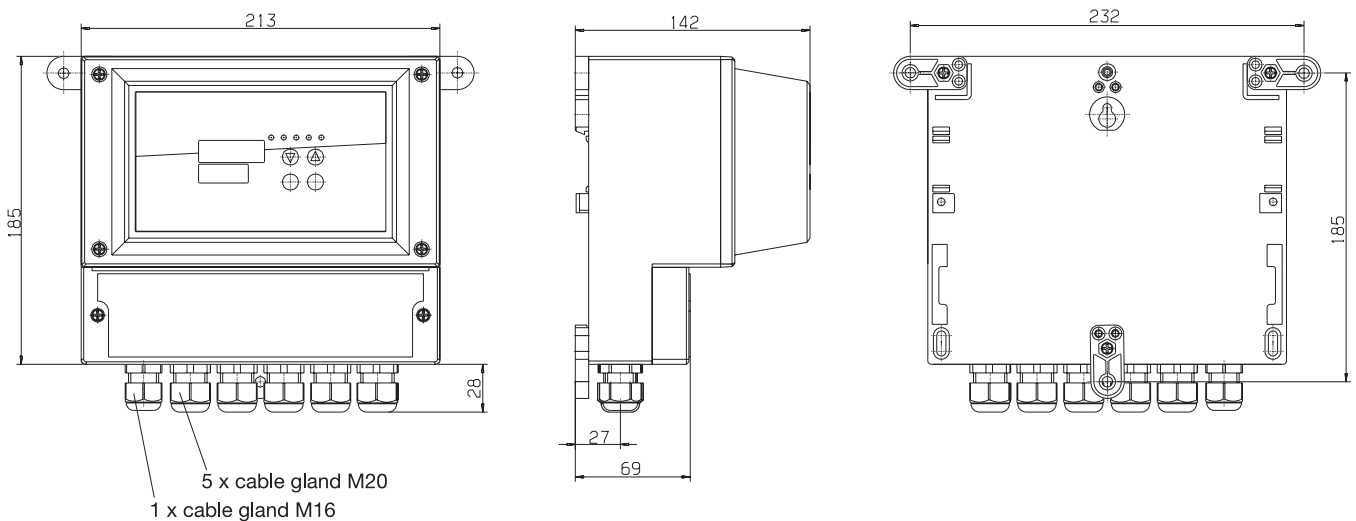

Type designation

(1) Basic type

202540 dTRANS Lf 01,
microprocessor transmitter/controller for conductivity

(2) Basic type extensions

10 Limit controller*

(3) Output I

000 no output
310 relay, changeover contact
888 process value output, freely configurable

(4) Output II

000 no output
310 relay, changeover contact¹
888 process value output, freely configurable¹

(5) Supply voltage

22 20 — 53 V AC/DC, 48 — 63/0 Hz
23 110 — 240 V AC +10%/-15%, 48 — 63 Hz

(6) Interface

00 no serial interface
54 serial interface RS422/485¹
64 serial interface Profibus-DP¹

(7) Extra codes

000 no extra codes
015 logic output 0/12 V DC,
instead of standard 0/5 V DC
640 surface-mounting housing for mounting on wall or DIN rail, IP67 protection

***Generally**

on all controllers of the 202540 series, the user can freely select the following configurations:

- Controller off
- Limit controller
- Pulse width controller with P, PI, PD, PID control action
- Pulse frequency controller with P, PI, PD, PID control action
- Modulating controller

¹ If output II (4) = "310" or "888" then the interface option (6) is not possible (or the other way round)!

(1) (2) (3) (4)¹ (5) (6)¹ (7)

Order code 202540 / 10 - [] , [] - [] - [] - []

Order example 202540 / 10 - 888 , 000 - 23 - 00 - 000

Stock items

Type	Sales No.
202540/10-888,000-23-00/000	20/00377231
202540/10-888,000-23-00/640	20/00431436

Non stock items

Type	Sales No.
202540/10-888,000-22-00/000	20/00401180

Optional accessories 1 (switchgear cabinet instrument)

Designation	Sales No.
Bracket for C-rail	70/00375749
Blind cover 96 x 48 mm	70/00069680

Optional accessories 2 (wall-mounting instrument)

Designation	Sales No.
Pole clamp, 60 mm dia. (clamping area: 50 — 70 mm dia.)	20/00437485
Pole clamp, 120 mm dia. (clamping area: 100 — 120 mm dia.)	20/00437486