

# eTRON T100

## Electronic thermostat with timer function for mounting on 35 mm DIN rail

### Brief description

The electronic thermostat measures the temperature via RTD temperature probe, thermocouple, or current 0(4) to 20 mA and can be configured as a simple heating or cooling thermostat depending on the set switching behavior.

The timer function can be used to start the thermostat function (heating or cooling) or to set a time limit to it.

The switching status of the relay and digital outputs as well as the actual value and setpoint value are shown simultaneously in the display. It has a resolution of 64 × 80 pixels, has background lighting, and can be switched to the national languages German, English, French, and Spanish.

The device is operated via 4 keys on the front panel. The electrical connection is made via terminal blocks with push-in technology.

A PhotoMOS® relay for limit value monitoring or a digital input for connecting a potential-free contact are available as options.

A setup program is available as an accessory for simple configuration, parameterization, and reading out of the data logger.



Type 701052/...

### Block diagram

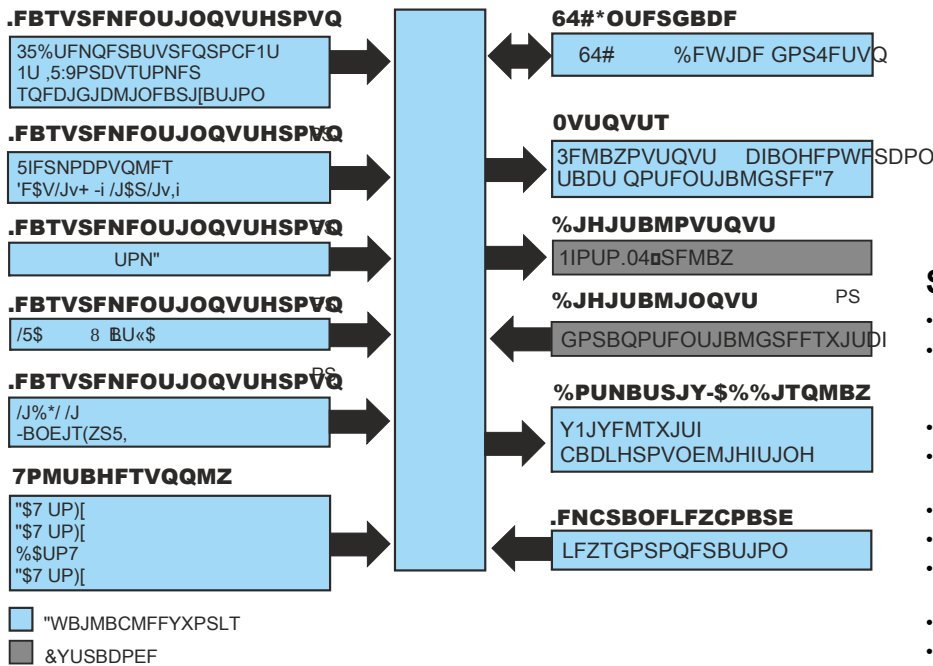

### Special features

- 5 different measuring input groups available
- Intuitive operation and configuration on the device or with the setup program through USB interface
- User level with 8 parameters
- Dot matrix display 64 x 80 pixels with 4 national languages
- Data logger function
- Service and operating hours counter
- Connection via terminal blocks with push-in technology
- 10 A relay (changeover contact)
- Customer-specific linearization in the setup program
- Limit value monitoring function
- Timer function
- Connection diagram retrievable in the LCD display

### Approvals/approval marks (see "Technical data")



## Technical data

### Analog input

The following measurement input variants can be ordered.

#### Measurement input group 1 (RTD temperature probe)

Designation	Standard	Measuring range	Measuring accuracy <sup>a</sup>	Ambient temperature influence	ITS
Pt100, Pt1000 in 2/3-wire circuit	IEC 60751:2008	-200 to +600 °C	≤ 0.25 %	≤ 0.1 · 10 <sup>-3</sup> 1/K	90
KTY 2X-6 in 2-wire circuit		-50 to +150 °C	≤ 1 %	≤ 0.1 · 10 <sup>-3</sup> 1/K	-
Customer table		150 Ω to 3000 Ω	≤ 0.25 %	≤ 0.1 · 10 <sup>-3</sup> 1/K	-
Measuring current	Approx. 0.5 mA				
Sensor line resistance	≤ 30 Ω per line for 2 and 3-wire circuit				
Lead compensation	Not required for 3-wire circuit. In 2-wire circuits, lead compensation is performed in the software by entering a fixed line resistance.				
Special features	Can also be programmed in °F				

<sup>a</sup> The accuracy specifications refer to the maximum measuring range. Smaller measuring spans lead to reduced linearization accuracy.

#### Measurement input group 2 (thermocouple)

Designation	Standard	Measuring range	Measuring accuracy <sup>a</sup>	Ambient temperature influence <sup>b</sup>	ITS
Fe-CuNi "L"	DIN 43710:1985-12	-200 to +900 °C	±0.4 %	≤ 0.1 · 10 <sup>-3</sup> 1/K	68
Fe-CuNi "J"	DIN EN 60584-1:2014	-210 to +1200 °C	±0.4 % from -100 °C	≤ 0.1 · 10 <sup>-3</sup> 1/K	90
NiCr-Ni "K"	DIN EN 60584-1:2014	-270 to +1300 °C	±0.4 % from -80 °C	≤ 0.1 · 10 <sup>-3</sup> 1/K	90
Customer table		-15 to 75 mV	±0.4 %	≤ 0.1 · 10 <sup>-3</sup> 1/K	
Measuring range start/end	Freely programmable within the limits in steps of 0.1 K				
Cold junction	Internal measurement via Pt1000 or external constant 0 °C				
Cold junction accuracy (internal)	±1 K				
Special features	Can also be programmed in °F				

<sup>a</sup> The accuracy specifications refer to the maximum measuring range. Smaller measuring spans lead to reduced linearization accuracy.

<sup>b</sup> The ambient temperature influence can be guaranteed in the range from -20 to +55 °C.

#### Measurement input group 3 (standard signal)

Designation	Measuring range	Measuring accuracy <sup>a</sup>	Ambient temperature influence
Current (voltage drop ≤ 2.5 V), freely scalable	0 to 20 mA 4 to 20 mA	≤ 0.125 %	≤ 0.1 · 10 <sup>-3</sup> 1/K deviation from 22 °C
Customer table	0 to 20 mA	≤ 0.125 %	
Special features	Scaling adjustable		

<sup>a</sup> The accuracy specifications refer to the maximum measuring range. Smaller measuring spans lead to reduced linearization accuracy.

### Measurement input group 4 (NTC railway)

Designation	Measuring range	Measuring accuracy	Ambient temperature influence
NTC resistance (5 k $\Omega$ at 25 °C) for railway applications	-55 to +150 °C		Deviation from 22 °C in the following ranges: -55°C to 100°C: $\leq 0.1 \cdot 10^{-3} 1/K$ 100°C to 130°C: $\leq 0.2 \cdot 10^{-3} 1/K$ 130°C to 150°C: $\leq 0.45 \cdot 10^{-3} 1/K$
Customer table	400 $\Omega$ to 40 k $\Omega$	$\leq 0.15 \%$	$\leq 0,1 \cdot 10^{-3} 1/K$
Connection type	2-wire circuit		
Measuring current	Approx. 0.1 mA		

### Measurement input group 5

Designation	Measuring range	Measuring accuracy <sup>a</sup>	Ambient temperature influence	ITS
Ni 1000 DIN 43760:1987-09	-60 to +250 °C	$\leq 0.25 \%$	$\leq 0.1 \cdot 10^{-3} 1/K$ deviation from 22 °C	68
LG-Ni 1000 Landis & Gyr TK5000 (Siemens HVAC)	-60 to +250 °C	$\leq 0.25 \%$	$\leq 0.1 \cdot 10^{-3} 1/K$ deviation from 22 °C	
Customer table	150 $\Omega$ to 3000 $\Omega$	$\leq 0.25 \%$		
Sensor line resistance	$\leq 30 \Omega$ per line			
Connection type	2-wire circuit			
Special features	Can also be programmed in °F			

<sup>a</sup> The accuracy specifications refer to the maximum measuring range. Smaller measuring spans lead to reduced linearization accuracy.

### Measuring circuit monitoring

In the event of a malfunction, the outputs move to a defined (configurable) status.

Measuring probe	Probe/cable break	Probe/cable short circuit
RTD temperature probe	Is detected	Is detected
KTY 2X-6	Is detected	Is detected
Thermocouple (single)	Is detected	Is not detected
Current 4 to 20 mA 0 to 20 mA	Is detected Is not detected	Is detected Is not detected
NTC railway applications	Is detected	Is detected
Ni 1000, LG-Ni 1000	Is detected	Is detected

### Digital input and digital output

Designation	Function
Potential-free contact (option) or PhotoMOS® relay (option)	For connection to a commercial switch or contact Switch-on resistance < 1 k $\Omega$ , switch-off resistance > 50 k $\Omega$ , max. DC 45 V, 200 mA, max. AC 30 V, 200 mA
Relay output	Relay (changeover contact) AC 250 V, 10 A (resistive load) 150000 switching operations at rated load

### Display

Type, resolution	Dot matrix LCD display with 64 × 80 pixels
Settings	Contrast, brightness, and backlight function

## Housing

Site altitude	Max. 2000 m above sea level
Case type, material	Plastic case, polycarbonate according to DIN EN 45545 (halogen-free, only for indoor use)
Flammability class	UL94 V0
Electrical connection	Via terminal blocks with push-in technology
Mounting on	Mounting rail 35 mm × 7.5 mm according to DIN IEC 60715
Close mounting	Permitted
Installation position	Vertical
Protection type	IP20 according to DIN EN 60529
Weight	Approx. 110 g

## Electrical data

Voltage supply	AC 230 V, +10/-15 %, 48 to 63 Hz or AC 115 V, +10/-15 %, 48 to 63 Hz or
	DC 12 to 24 V +15/-15 % <sup>a</sup> / AC 24 V +15/-15 %, 48 to 63 Hz (The device has only to be connected at SELV- or PELV-circuits)
Power consumption	With voltage supply 230 V: max. 1.5 W, 2.0 VA With voltage supply 115 V: max. 1.5 W, 2.0 VA With voltage supply DC 12 to 24 V: max. 1.2 W With voltage supply AC 24 V +15/-15 %: max. 0.8 W, 1.8 VA
Inputs and outputs Conductor cross section	Max. 2.5 mm <sup>2</sup> , wire or strand with ferrule
Electrical safety	According to DIN EN 61010-1 Overvoltage category III, pollution degree 2
Analog inputs	Connection only to SELV (secondary circuits)
Sampling rate	250 ms
Input filter	Digital filter, 2nd order; filter time constant can be adjusted from 0 to 100.0 s
Accuracy of timer and operating hours counter	1%

<sup>a</sup> For railway applications (Extra code 950) only a mains supply voltage of DC 24V +15/-15% is approved.

## Environmental influences

Operating, storage temperature range	-40 to +55 °C (display to min. -10 °C), -40 to +70 °C
Resistance to climatic conditions	≤ 85% relative humidity, annual average, no condensation
Electromagnetic compatibility Interference emission Interference immunity	According to DIN EN 61326-1, DIN EN 50121-1 / 50121-3-2 Class B Class B <sup>a</sup> Industrial requirement

<sup>a</sup> The product is suitable for industrial use as well as for households and small businesses.

## Approvals/approval marks

Approval mark	Test facility	Certificate/certification number	Inspection basis	Valid for
c UL us	Underwriters Laboratories	E201387	UL 61010-1	All modules

## Data logger

The configuration and Data logger values are saved in the EEPROM. After a power loss the data will be retained.

Recording interval	Recording durance
1 min	ca. 1 day, 20 hours
5 min	ca. 9 days, 8 hours
15 min	ca. 28 days, 2 hours
30 min	ca. 1 month, 25 days
60 min	ca. 3 month, 9 days

## Display and control elements

Legend	Comment
(1)	LCD display Black/white with background lighting, 64 × 80 pixels
(2)	4 keys for operating the device
(3)	USB device For connection to the setup program.

## Galvanic isolation

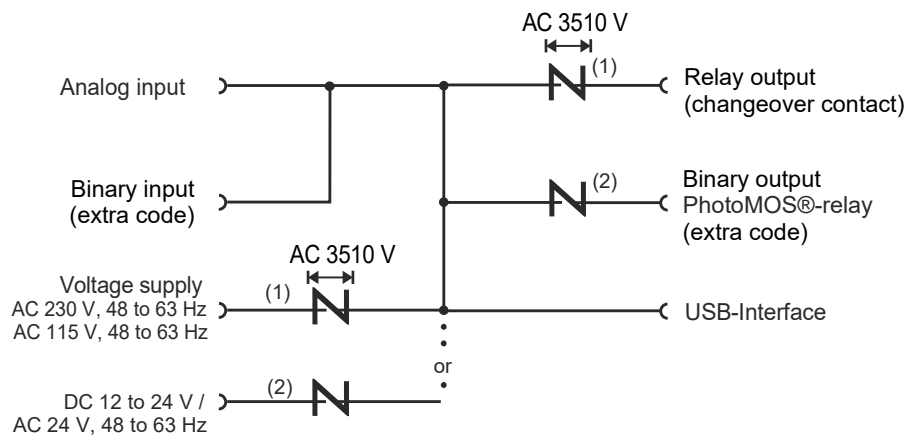

(1) The voltage specifications correspond to the test voltages (alternating voltage, rms values) according to EN 61010-1:2011-07 for the type test.

(2) Functional galvanic isolation for the connection of SELV or PELV circuits.

# Limit value monitoring

The relay output can be activated as follows depending on an adjustable limit value (1):

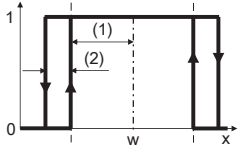
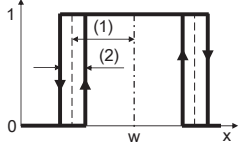
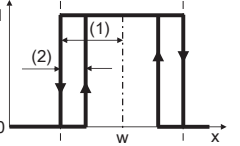
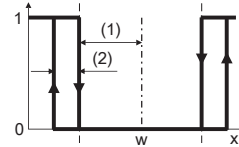
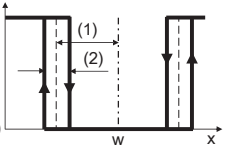
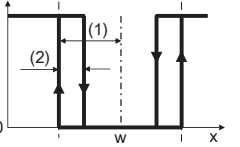
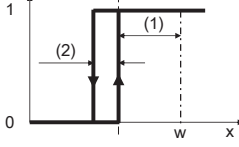
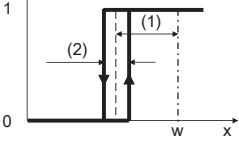
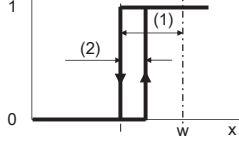
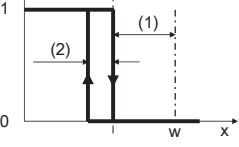
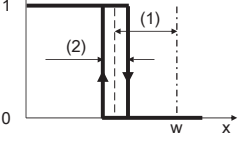
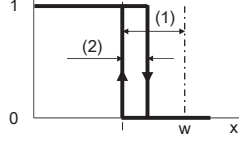
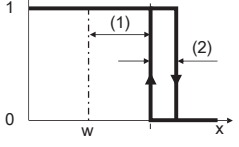
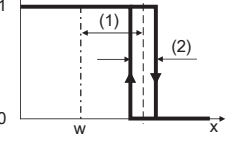
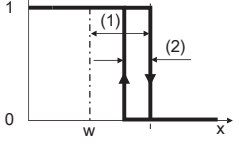
Left	Symmetrical	Right
<b>Switching functions in relation to setpoint value</b>		
<b>Alarm function 1 (AF1):</b> Window ON  <p>(1) Distance from setpoint value, (2) switching differential</p>	<b>Alarm function 1 (AF1):</b> Window ON  <p>(1) Distance from setpoint value, (2) switching differential</p>	<b>Alarm function 1 (AF1):</b> Window ON  <p>(1) Distance from setpoint value, (2) switching differential</p>
<b>Alarm function 2 (AF2):</b> Window OFF  <p>(1) Distance from setpoint value, (2) switching differential</p>	<b>Alarm function 2 (AF2):</b> Window OFF  <p>(1) Distance from setpoint value, (2) switching differential</p>	<b>Alarm function 2 (AF2):</b> Window OFF  <p>(1) Distance from setpoint value, (2) switching differential</p>
<b>Alarm function 3 (AF3):</b> OFF switching operation below setpoint value  <p>(1) Distance from setpoint value, (2) switching differential</p>	<b>Alarm function 3 (AF3):</b> OFF switching operation below setpoint value  <p>(1) Distance from setpoint value, (2) switching differential</p>	<b>Alarm function 3 (AF3):</b> OFF switching operation below setpoint value  <p>(1) Distance from setpoint value, (2) switching differential</p>
<b>Alarm function 4 (AF4):</b> ON switching operation below setpoint value  <p>(1) Distance from setpoint value, (2) switching differential</p>	<b>Alarm function 4 (AF4):</b> ON switching operation below setpoint value  <p>(1) Distance from setpoint value, (2) switching differential</p>	<b>Alarm function 4 (AF4):</b> ON switching operation below setpoint value  <p>(1) Distance from setpoint value, (2) switching differential</p>
<b>Alarm function 5 (AF5):</b> OFF switching operation above setpoint value  <p>(1) Distance from setpoint value, (2) switching differential</p>	<b>Alarm function 5 (AF5):</b> OFF switching operation above setpoint value  <p>(1) Distance from setpoint value, (2) switching differential</p>	<b>Alarm function 5 (AF5):</b> OFF switching operation above setpoint value  <p>(1) Distance from setpoint value, (2) switching differential</p>

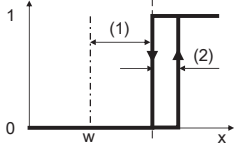
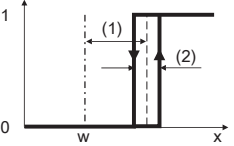
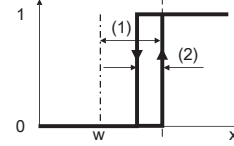
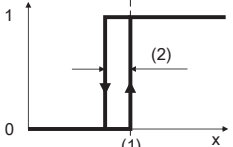
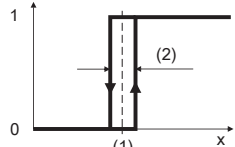
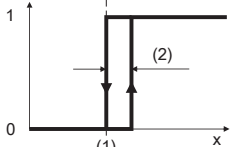
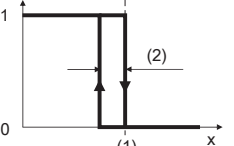
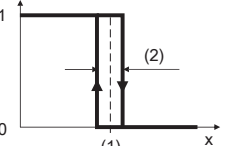
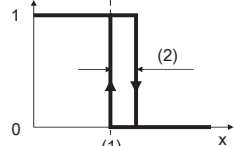
<p><b>Alarm function 6 (AF6):</b> ON switching operation above setpoint value</p>  <p>(1) Distance from setpoint value, (2) switching differential</p>	<p><b>Alarm function 6 (AF6):</b> ON switching operation above setpoint value</p>  <p>(1) Distance from setpoint value, (2) switching differential</p>	<p><b>Alarm function 6 (AF6):</b> ON switching operation above setpoint value</p>  <p>(1) Distance from setpoint value, (2) switching differential</p>
<p><b>Switching functions in relation to limit value</b></p>		
<p><b>Alarm function 7 (AF7):</b> ON switching operation from a fixed limit value</p>  <p>(1) limit value, (2) switching differential</p>	<p><b>Alarm function 7 (AF7):</b> ON switching operation from a fixed limit value</p>  <p>(1) limit value, (2) switching differential</p>	<p><b>Alarm function 7 (AF7):</b> ON switching operation from a fixed limit value</p>  <p>(1) limit value, (2) switching differential</p>
<p><b>Alarm function 8 (AF8):</b> OFF switching operation from a fixed limit value</p>  <p>(1) limit value, (2) switching differential</p>	<p><b>Alarm function 8 (AF8):</b> OFF switching operation from a fixed limit value</p>  <p>(1) limit value, (2) switching differential</p>	<p><b>Alarm function 8 (AF8):</b> OFF switching operation from a fixed limit value</p>  <p>(1) limit value, (2) switching differential</p>

## Connection elements



(L1, N, L+, L-) Voltage supply (according to nameplate)

(3, 4)

Digital input or PhotoMOS® relay  
(option according to nameplate)

(1, 2, 3) Actual value of analog input

(5, 6, 7)

Relay output

## Connection diagram

The connection diagram in the data sheet provides preliminary information about the connection options. For the electrical connection, only use the installation instructions or the operating manual. The knowledge and the correct technical execution of the safety information and warnings contained in these documents are mandatory for installation, electrical connection, startup, and for safety during operation.

### Actual value of analog input

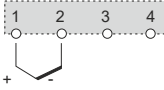
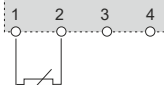
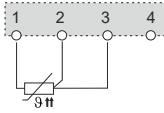
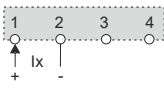
Connection	Connection terminal	Symbol and terminal designation
Thermocouple	(1, 2)	
- RTD temperature probe Pt100 / Pt1000 - KTY 2X-6 - NTC railway - Ni1000 - LG-Ni 1000 in 2-wire circuit	(1, 2)	
RTD temperature probe Pt100 / Pt1000 in 3-wire circuit	(1, 2, 3)	
Current DC 0(4) to 20 mA	(1, 2)	

### Digital input or output PhotoMOS® relay K2 (option)

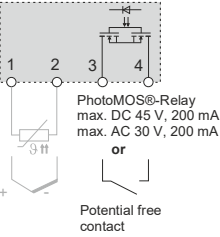
Connection	Connection terminal	Symbol and terminal designation
<b>Note:</b> If the PhotoMOS® relay or digital input option is selected, a Pt100 / Pt1000 RTD temperature probe <b>cannot</b> be connected in a 3-wire circuit.	(3, 4)	

### Digital output relay K1

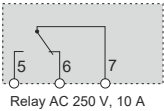
Connection	Connection terminal	Symbol and terminal designation
Relay, changeover contact (zero-current state)	(5, 6, 7)	



## Voltage supply (according to nameplate)

Connection	Connection terminal	Picture
AC 115V or AC 230 V	<b>AC:</b> L1 line conductor N Neutral conductor	
DC 12 to 24 V or AC 24 V (The device has only to be connected at SELV- or PELV-circuits)	<b>DC:</b> (L+) (L-)	

## Interfaces

### USB (device)

Connection	Connection terminal	Picture
USB interface (device) Micro-B connector, standard (5-pole)		

## Dimensions

The device size described in DIN 43880 (Built-in equipment for electrical installations; overall dimensions and related mounting dimensions) is complied with.

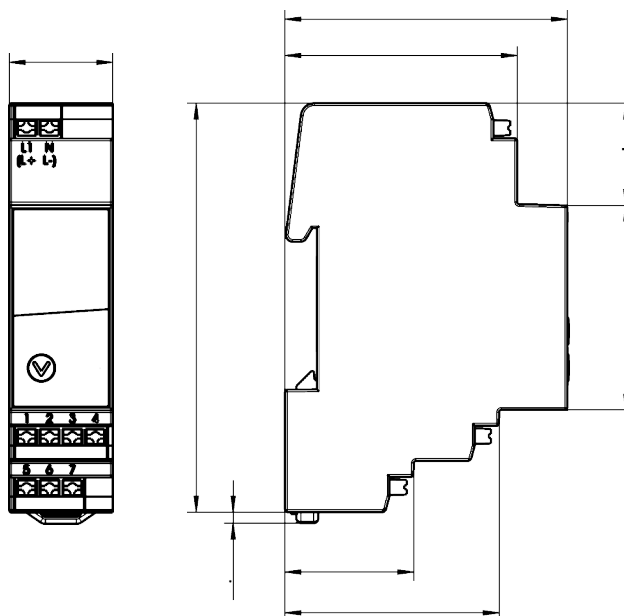

## Order details

<b>(1) Basic type</b>	
701052	eTRON T100 for mounting on DIN rail ( 1 relay output changeover contact 10A)
<b>(2) Version</b>	
8	Standard with default settings
9	Customer-specific configuration (specifications in plain text)
<b>(3) Input</b>	
01	RTD temperature probes Pt100, Pt1000, KTY2X-6
02	Thermocouple
03	0(4) to 20 mA
04	NTC (5 kΩ at 25 °C) for railway applications
05	Ni1000 DIN 43760, Ni1000 Landis & Gyr TK 5000 for railway applications
<b>(4) Voltage supply (operating conditions according to DIN EN 50121)</b>	
02	AC 230 V, +10/-15 %, 48 to 63 Hz
05	AC 115 V, +10/-15 % <sup>a</sup> , 48 to 63 Hz
31	DC 12 to 24 V +15/-15 % / AC 24 V +15/-15 %, 48 to 63 Hz (The device has only to be connected at SELV- or PELV-circuits)
<b>(5) Options</b>	
00	None (connection of Pt100 / Pt1000 RTD temperature probes in three-wire circuit is possible)
01	Digital output PhotoMOS® relay (connection of a three-wire circuit <b>is not</b> possible)
02	Digital input for potential-free contact (connection of a three-wire circuit <b>is not</b> possible)
<b>(6) Extra codes</b>	
950	Suitable for railway applications according to DIN EN 50155 <sup>a</sup> , the declaration of manufacturer is available in the Internet under <a href="http://www.jumo.de">http://www.jumo.de</a>

<sup>a</sup> For railway applications (Extra code 950) only a mains supply voltage of DC 24V +15/-15% is approved.

Order code      **(1)**      **(2)** - **(3)**      **(4)**      **(5)**      **(6)**  
 Order example      701052 / 8 - 01 - 02 - 00 / 950 , ...

## Scope of delivery

- JUMO eTRON T100 in the ordered version
- 1 operating manual (leaflet)

## General accessories

Item	Part no.
Setup program on CD-ROM, multilingual	00702233
USB cable A-connector to Micro-B connector, length 3 m, for type 701052	00616250
Screw-on end clamp for mounting rail	00528648